



富大橡胶

FUDA CONVEYOR BELT



富岳®

浙江富大橡胶有限公司 ZHEJIANG FUDA RUBBER CO.,LTD

国内贸易电话: 0576-83019080 0576-83019888
Domestic trade tel: 0576-83019080 0576-83019888
国际贸易电话: 0086-576-83070118
International trade tel: 0086-576-83070118
传真/Fax: 0576-83019528 0086-576-83019528
网址/Web: www.fudaxj.com
邮箱/Email: fudaxj@163.com
地址: 浙江省天台县洪畴镇洪三工业园区
Add: HongsanIndustrialZone, Hongchou, Tiantai, Zhejiang,
317210, China.

浙江富大橡胶有限公司
ZHEJIANG FUDA RUBBER CO.,LTD

公司简介

浙江富大橡胶有限公司成立于1990年，多年来一直专注于橡胶输送带的生产，公司现拥有占地面积21000平方米，建筑面积15000平方米，拥有固定资产一亿两千万人民币，注册资金六千万人民币，是集产品研发，设计，生产，销售及服务于一体的生产基地。

公司生产各种类型的输送带和传动带，输送带包括聚酯输送带，尼龙输送带，钢丝绳输送带，棉布输送带，阻燃输送带，耐热输送带，耐寒输送带，耐油输送带和耐酸碱输送带等，产品畅销全国各大省份，并出口到欧洲，中东，南美洲，非洲，东南亚等60多个国家和地区，在市场上有较高的知名度和美誉度。

我司通过了ISO9001:2000质量体系认证，是台州市著名商标，与国内橡胶制品权威院校—青岛科技大学建立了长期合作，经常探讨新技术，新材料的开发与应用。现获得各类专利15项。公司以“立足国内，展望世界”为追求目标，坚持“以质量求生存，以科技求发展，以信誉求合作”的宗旨，竭诚为广大客户提供最优质的服务。

董事长兼总经理

丁金佑

浙江富大输送带
0576-83019888

富大橡胶

浙江富大橡胶有限公司
ZHEJIANG FUDA RUBBER CO., LTD.

COMPANY PROFILE

ZHEJIANG FUDA RUBBER CO.,LTD was founded in 1990 , has been focused on rubber conveyor belt production for years. Our company covers an area of 21000 square meter and has 15000 Square meter of building parts. We have fixed assets of 130 million Yuan, registered capital of 68 billion Yuan, its a set of products R&D, design ,production, sales and service in one of the production base of rubber belt .

Our company mainly manufacture all kinds of conveyor belt and transmission belt .Conveyor belt including polyester conveyor belt ,nylon belt ,steel cord conveyor belt ,cotton belt ,fire resistant conveyor belt, heat resistant conveyor belt, cold resistant conveyor belt ,oil resistant conveyor belt and chemical resistant conveyor belt etc . Products sells in all province of domestic market ,and exported to the Middle East, Europe, South America, Southeast Asia, Africa, more than 60 countries and region, won a good visibility and reputation .

We have passed the ISO9001 :2000 quality management system certification, we are famous trade mark of Zhejiang Province. Our company attaches great importance to new technology, new materials , and domestic rubber authoritative institutiona—Qingdao University of Science and Technology of establish a long-term relationship . The company now has 15 patents . With the goal of "basing itself on the domestic market and looking forward to the world", the company adheres to the tenet of "surviving by quality, developing by science and technology, cooperating by reputation", and provides the best service to the every customers.

GENERAL MANERGER: DING JIN YOU

富大橡胶

橡胶之城



质量认证 Iso certificate



企业荣誉 Honor

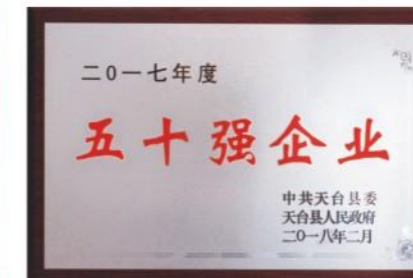

创新共赢 共创未来

诚信

“诚信、共赢” 经营理念

专业技术 安全 高品质 精益求精 值得信赖



质量第一 顾客满意 开拓创新 诚信立业

Quality First, Customer Satisfaction, Innovation and Honesty

先进设备

Advanced equipments

富大注重生产设备的更新换代和转型升级,采用先进设备和生产工艺,拥有2500MM宽度平板硫化机,通过ISO9001-2008国际质量体系认证并获得台州市著名商标。

Fuda emphasize on the production equipment renewal and transformation upgrade , adopt advanced machines , technology and excellent service .we have 2500mm width vulcanizing machine, passed ISO9001-2008 international quality system, Fuda was rate as "famous trademark of taizhou city" .



>>>

技术，定位企业的生存和发展 设备，衡量企业视野的尺度

Technology determines the life and development of enterprises.
Equipments scale the ability of researching and inventing of one enterprise.



检测设备

Testing center

富大视质量为生命，严把质量关。我们拥有一套完整的理化检测设备和一支质量管理队伍，引进台湾高特威尔公司的电子拉力机，无转子硫化仪，磨耗机，门尼机等国际领先的检测设备，可对原材料分析，半成品控制，成品物理性能等多个项目进行检测。

Fuda regards the quality of life, strict quality control. We have a complete set of physical and chemical testing equipment and a quality management team, the introduction of Taiwan Gotech's electronic tensile machine, moving die rheometer, abrasion machine, mooney viscometer and other international leading testing equipment, raw material analysis, semi-finished products control, finished product physical properties and other projects for testing.



产品至精 服务至善
追求卓越 创优质品牌

Extreme users, talent first, to refined products,
Service excellence, the pursuit of excellence, a quality brand.

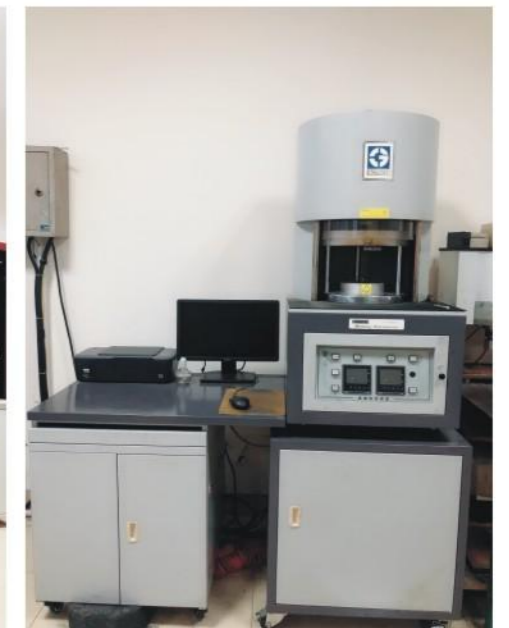
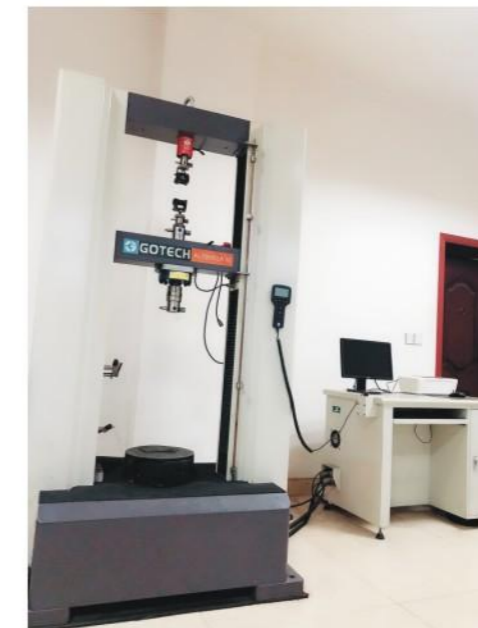



与瞻远瞩



<input type="checkbox"/> 公司简介 Company profile	01
<input type="checkbox"/> 先进设备 Advanced equipments	05
<input type="checkbox"/> 检测设备 Testing center	07
<input type="checkbox"/> 耐灼烧输送带 Burning-through resistant conveyor belt	10
<input type="checkbox"/> 耐高温输送带 High temperature resistant conveyor belt (EPDM)	11
<input type="checkbox"/> 耐热输送带 Heat resistant conveyor belt	12
<input type="checkbox"/> 钢丝绳芯输送带 Steel cord conveyor belt	13
<input type="checkbox"/> 聚酯输送带 EP conveyor belt	15
<input type="checkbox"/> 尼龙输送带 NN conveyor belt	17
<input type="checkbox"/> 棉布输送带 Cotton conveyor belt	18
<input type="checkbox"/> 耐酸碱输送带 Chemical resistant conveyor belt	19
<input type="checkbox"/> 一般用途织物芯阻燃输送带 Fire resistant conveyor belt	20
<input type="checkbox"/> 耐油输送带 Oil resistant conveyor belt	21
<input type="checkbox"/> 耐寒输送带 Cold resistant conveyor belt	22
<input type="checkbox"/> 糙面输送带 Rough top conveyor belt	23
<input type="checkbox"/> 花纹输送带 Chevron conveyor belt	24
<input type="checkbox"/> 波形挡边输送带 Side wall conveyor belt	25
<input type="checkbox"/> 环形输送带 Endless conveyor belt	26
<input type="checkbox"/> 食品输送带 White conveyor belt	26
<input type="checkbox"/> 平胶带 Flat transmission belt	27
<input type="checkbox"/> 普通V带 Classical wrapped v-belt	28
<input type="checkbox"/> 窄V带 Wedge wrapped v-belt	28

耐灼烧输送带

Burning-through resistant conveyor belt

用途 >>>

广泛应用于冶金、铸造、水泥、化工等行业。输送物料的温度可达180℃~250℃，瞬间可达600℃。

特点 >>>

- 1、近工作面强力层上方覆盖一层特种耐热织物（GF帆布）、强力层采用耐高温聚酯帆布。
- 2、覆盖层胶料配方独特，在输送高温物料时，表面形成绝热炭化层。
- 3、优异的贴胶配方，保证在高温条件下，布层间具有较高附着力，避免使用过程中产生脱层起泡等弊病，稳定性好，使用寿命长。

Application

The burning-through resistant conveyor belt can be widely used in metallurgical, casting, cement and chemical industries for conveying of materials whose temperature can reach 180℃~250℃, also can bear 600℃ for short time.

Feature

The reinforcement ply of the belt used by the special glass-fibre, (called Gfabric). The conveyor belt has excellent stability and high-heat resistant, so the belt service life is prolonged.

规格系列 Size Series >>>

织物型号 Type of Fabric		强力层织物EP Reinforcement D.S.EP	覆盖胶厚度 (mm) Cover Thickness(mm)		布层数 NO.of Ply		生产宽度范围 Width Range (mm)
GF帆布	EP帆布	单层强度N/mm	上胶	下胶	GF帆布	D.S.EP帆布	
GF	EP100	100	≥7	≥3	1	2-6	450-2300
GF	EP150	150	≥7	≥3	1	2-6	450-2300
GF	EP200	200	≥7	≥3	1	2-6	450-2300
GF	EP250	250	≥7	≥3	1	2-6	450-2300
GF	EP300	300	≥7	≥3	1	2-6	450-2300
GF	EP350	350	≥7	≥3	1	2-6	450-2300
GF	EP400	400	≥7	≥3	1	2-6	450-2300



耐高温输送带

High temperature resistant conveyor belt (EPDM)

织物型号 Fabric Spec EP-80~EP-400 CC-56 T.C~75

宽度width (mm) 300~2300

产品特点 >>>

本产品带芯采用高模量、低收缩、扯断强度极高的聚酯帆布, 覆盖胶选用耐高温性能很好的三元乙丙胶或氯化丁基橡胶, 并配全耐高温材料进行复合成型、硫化等工序精制而成。该产品带芯经过和特殊浸渍定型处理后, 粘合强度高, 在200°C以下正常使用条件下, 伸长变形小, 磨耗性能优异。在短时间内可承受400°C高温。适用于水泥、焦化、冶金、钢铁等工业使用。

CHARACTERISTICS >>>

The belt carcass of this product is EP fabric of high modulus, low shrink, and high breaking tensile strength. Cover rubber of this product uses EPDM rubber or chlorobutadiene rubber, after process of shaping and vulcanizing, conveyor belt has very good high temperature resistance.

The carcass of this product has very high adhesion after the special treatment of coating and shaping. Under normal working condition with the temperature below 200°C, the belt is low elongation and excellent antiabrasion, it can also bear 400°C high temperature for short time. The belt is suitable for use in cement, metallurgical and steel industry.



耐热输送带

Heat resistant conveyor belt

用途 APPLICATION >>>

T1 有耐热要求, 物料温度不很高的场合使用, 不适用用于粉状物料

Cotton canvas conveyor belts could be applied in situations with heat resistance requests but not with high temperature materials. They can't be used to transport powder-like materials.

T2 用于有耐磨要求且温度适宜的场合, 或用于温度不很高的粉状物料

They can be used in situations with wearing resistance requests and moderate temperature or used to transport powder-like materials with moderate temperature.

T3 用于温度较高, 耐磨性要求较高的场合, 如烧结成品, 水泥熟料等

They can be used in situations of high temperature and with requests for high wearing resistance, such as sinter and cement clinker.

基本性能指标 BASIC PERFORMANCE INDICATORS >>>

项目 Item	类别 Class				
	T1	T2	T3	T4	
	试验温度 Test temperature				
	≤100°C	≤125°C	≤150°C	≤175°C	
	允许变化范围 Change range allowed				
硬度 Hardness	老化后与老化前之差 Difference before and after aging (IRHD)	±20	±20	±20	±20
	老化后的最大值 Maximum value after aging (IRHD)	85	85	85	85
拉伸强度 Tensile Strength	性能变化率降低 Change rate of property / %	-25	-30	-40	-40
	老化后的最低值 Minimum value after aging / Mpa	12	10	5	5
扯断伸长率 Breaking Elongation	性能变化率 Change rate of property / %	-50	-50	-55	-55
	老化后的最低值 Minimum value after aging / %	200	200	180	180



钢丝绳芯输送带 Steel cord conveyor belt

分类 Classification >>>

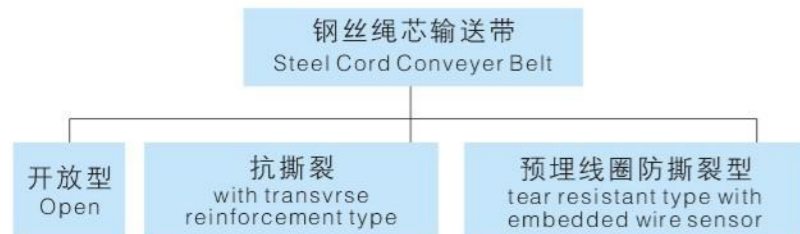

用途 Application >>>

可广泛应用于煤炭、矿山、港口、冶金、电力、化工等领域实现长距离、大运量、高速度输送物料。

Can be widely used in coal industry, mines, ports, metallurgical industry, power plant and chemical industry for conveying materials.

结构 >>>

由纵向均匀排列左、右交互捻的开放式镀锌钢丝绳与粘性能优异的芯胶组成带芯，上、下边部覆以橡胶层，形成带体。

Structure and Feature >>>

Conventional Structure Type

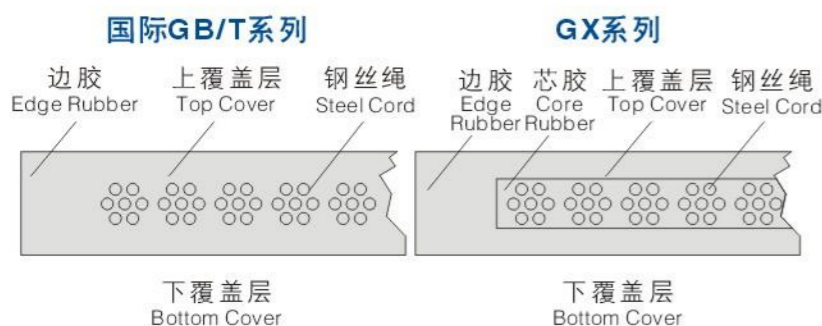
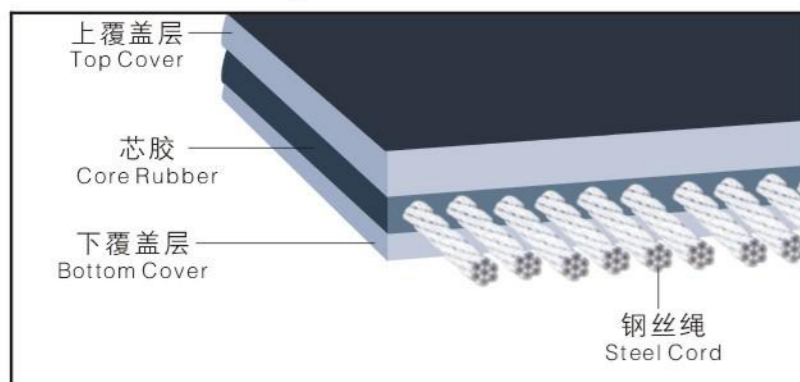

钢丝绳芯输送带 Steel cord conveyor belt

胶带标准规格 Standard belt specifications >>>

胶带强力 Belt strength (St-No.)	钢丝绳直径 Cord diam d(mm)	钢丝绳结构 Composition	绳间距 Pitch p(mm)	标准工作拉力 Standard Working tension(N/mm)	标准盖胶厚度 Standard cover thickness,t _c (mm)	带重 Belt weight (kg/m ²)	最小辊筒直径 Min. pulley diam.(mm)	钢丝绳强度KN/根 Cord strength KN/piece
st-630	3.0	6X7+IWS	10	90	5+5	20.0	800	6.93
st-800	3.5	6X7+IWS	10	110	5+5	20.6	800	8.8
st-1000	4.0	6X7+IWS	12	140	6+6	24.7	800	13.2
st-1250	4.5	6X7+IWS	12	175	6+6	25.4	800	16.5
st-1600	5.0	6X19+IWS	12	225	6+6	26.0	1000	21.12
st-2000	6.0	6X19+IWS	12	285	8+6	30.0	1000	26.4
st-2500	7.2	6X19W+IWS	15	355	8+6	32.2	1250	41.25
st-3150	8.1	6X19W+IWS	15	450	8+8	35.7	1400	51.98
st-4000	8.9	6X19W+IWS	15	570	8+8	37.8	1600	74.8
st-4500	9.7	6X19W+IWS	16	645	8+8	38.7	1800	79.2
st-5000	10.9	6X19W+IWS	17	715	8.5+8.5	41.9	1800	93.5
st-5400	11.3	6X19W+IWS	17	760	9+9	43.9	2000	101

钢丝绳根数 Number of steel cords >>>

宽度(mm) Belt width	ST630	ST800	ST1000	ST1250	ST1600	ST2000	ST2500	ST3150	ST4000	ST4500	ST5000	ST5400
800	75	75	63	63	63	63	50	50				
1000	95	95	79	79	79	79	64	64	64	59	55	55
1200	113	116	94	94	94	94	76	76	77	71	66	66
1400	133	133	111	111	111	111	89	89	90	84	78	78
1600	151	151	126	126	126	126	101	101	104	96	90	90
1800		171	143	143	143	143	114	114	117	109	102	102
2000			159	159	159	159	128	128	130	121	113	113
2200						176	141	141	144	134	125	125

ST系列 >>>

胶带型号	ST630	ST800	ST1000	ST1250	ST1600	ST2000	ST2500	ST3150	ST3500	ST4000	ST4500	ST5000	ST5400	ST6300
最小辊筒直径mm	500	500	630	800	1000	1000	1250	1400	1600	1600	1600	1800	1800	1800

聚酯输送带 EP conveyor belt

织物型号 Fabric Spec EP-80~EP+400

宽度width (mm) 300~2300

产品特性及用途 >>>

聚酯输送带又称EP输送带, 其抗拉体为经向涤纶, 纬向为锦纶交织而成的帆布, 其性能特点是经向的低延伸率和纬向的优良成槽性能, 耐水性好, 湿态强度不下降, 不发生霉变, 聚酯的初始模量高, 可取较低的安全系数, 适用于中长距离较高载重、高速条件输送物料。

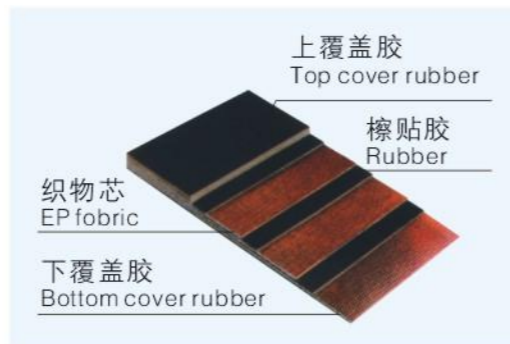

Product characteristics and usage >>>

Polyester conveyor belts, also called EP conveyor belts, which tension resistant body is canvas woven by polyester in warp and polyamine in welf. The belts have the characteristics of low elongation in warp and good troughability in welf, good water resistance, good wet strength, no mould, it is suitable for medium, long distance and heavy-load transportation of materials. Because of the high initial modulus of polyester, the belts can choose a relative low safety factor.

结构 Structure >>>

分为包边式和切边式

Can be classified into tow types: edge-wrapped and edge-cut

包边式
Mould edge

切边式
Cut edge

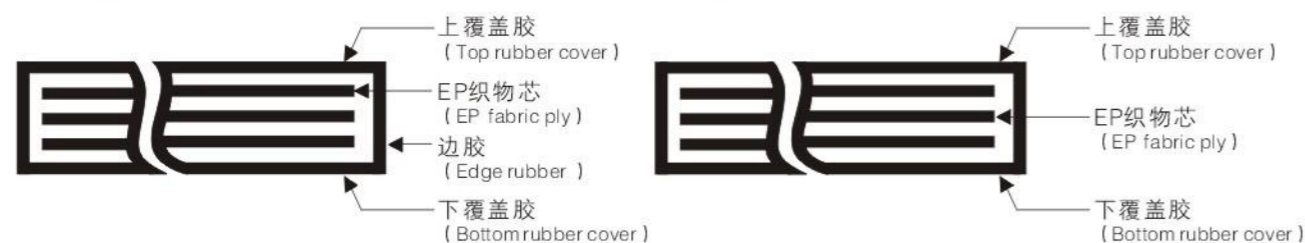

计量单位及计量方法 (Measuring unit and method) >>>

计量单位 (unit): 层平方米 (ply m²)

计量方法 (method): $m^2 = \frac{\text{宽度 (m)} \times (\text{布层数}) + \frac{\text{上下覆盖胶总数 (mm)}}{1.5} \times (\text{带长}) (m)}{\text{Fabric plies}}$

聚酯输送带 EP conveyor belt

多层聚酯织物芯输送带的规格及技术参数

Specincation and technical data of multi-ply EP conveyor belt >>>

织物类型 Fabric type	织物构造 Fabric structure		织物型号 Fabric Specs	胶布厚度 Ply thickness (mm/p)	强度系列 (N/mm) Strength series					覆盖厚度 (mm) Cover thickness		宽度范围 Width (mm)	带长 Length (m)	
	经 Warp	纬 Weft			2层 2ply	3层 3ply	4层 4ply	5层 5ply	6层 6ply	上覆盖胶 Upper	下覆盖胶 Lower			
聚酯 polyester (EP)	聚酯 polyester (EP)	涤纶 polyamide (P)	EP-80	0.60	160	240	320	400	480	2.0~8	0~4.5	400~2500	≤600	
			EP-100	0.75	200	300	400	500	600					
			EP-150	1.00	300	450	600	750	900					
			EP-200	1.10	400	600	800	1000	1200			800~2500		
			EP-250	1.25	500	750	1000	1250	1500					
			EP-300	1.35	600	900	1200	1500	1800			1000~2500		
			EP-350	1.45	-	1050	1400	1750	2100					
			EP-400	1.55	-	-	1600	2000	2400					
			EP-500	1.70	-	-	2000	2500	3000					

覆盖层物理性能 Physical property of cover rubber >>>

覆盖层类别 Type	拉伸强度 Tensile	扯断伸长率 Elongation		磨损 Abrasion	老化后拉伸强度和扯断伸长率变化率 Change rate of tensile strength and elongation at break after aging
	Mpa ≥	Kgf/cm ²	% ≥	mm ³ ≤	%
强划裂工作条件 (H)	24	240	450	120	-20~+25
强磨损工作条件 (D)	18	180	400	100	-20~+25
一般工作条件 (L)	15	150	350	200	-20~+25

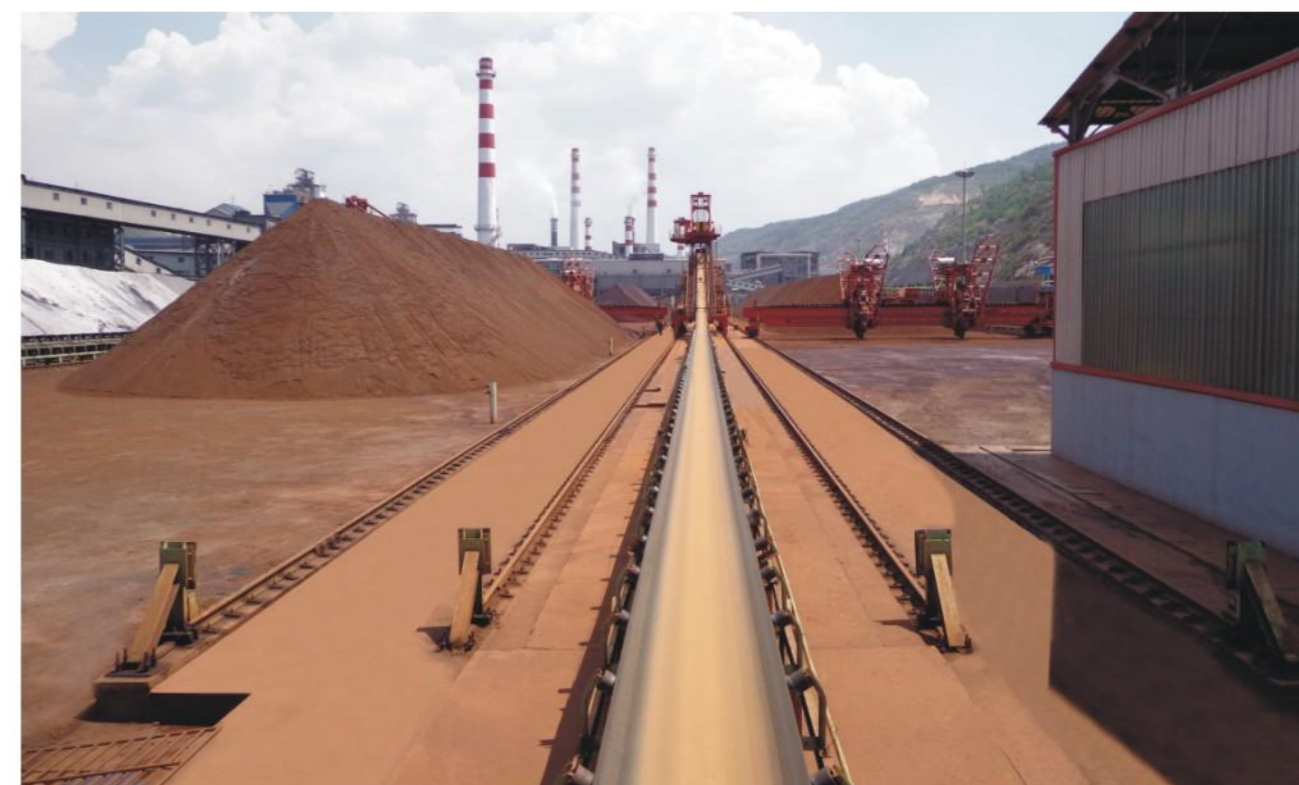

尼龙输送带

NN conveyor belt

织物型号 Fabric Spec NN-80~NN+400

宽度 width(mm) 300~2300

产品特性

尼龙是橡胶工业目前所用合成纤维中性能最好的品种之一, 其结构经纬向均为锦纶纤维编织, 用途最广的品种, 它最突出的优点是耐磨性好, 强度高, 耐疲劳性好, 尼龙帆布做成输送带具有体薄, 强力高, 耐冲击, 成槽性好, 层间粘合力大, 屈挠性优异及使用寿命长等特点, 适用于中长距离, 较高载量, 高速条件下输送物料, 广泛用于矿山、冶金、建筑、港口等部门。

Product characteris >>>

Nylon is one of the best quality synthetic fibers that the rubber industry use now. The nylon canvas is woven by nylon fibers both in warp and in weft. It is the most widely used fabric in rubber industry, and its outstanding merits are its high abrasion resistance, high tensile strength and good fatigue resistance. Conveyor belts with nylon canvas inside have the characteristics of thin belt body, high adhesion between plies, splendid flexibility and long working life. Nylon conveyor belts are suitable for medium, long-distance and heavy-load transportation of materials, widely used in mining, metallurgical industry and architectural industry, ports and etc.

技术指标 Technical indexes >>>

织物类型 Fabric type	织物构造 Fabric structure		织物型号 Fabric Specs	胶布厚度 Ply thickness (mm/p)	强度系列 (N/mm) Strength series					覆盖厚度 (mm) Cover thickness		宽度范围 Width (mm)	带长 Length (m)
	经 Warp	纬 Weft			2层 2ply	3层 3ply	4层 4ply	5层 5ply	6层 6ply	上覆盖胶 Upper	下覆盖胶 Lower		
尼龙 Nylon (NN)	锦纶 Nylon (N)	锦纶 Nylon (N)	NN-100	0.75	200	300	400	500	600	1.5-8	0-4.5	400-2500	≤600
			NN-150	0.80	300	450	600	750	900				
			NN-200	0.90	400	600	800	1000	1200				
			NN-250	1.15	500	750	1000	1250	1500				
			NN-300	1.25	-	900	1200	1500	1800				
			NN-400	1.45	-	-	1600	2000	2400				
NN-500	1.55	-	-	2000	2500	3000							

覆盖层物理性能 Physical property of cover rubber >>>

覆盖层类别 Type	拉伸强度 Tensile	扯断伸长率 Elongation		磨损 Abrasion	老化后拉伸强度和扯断伸长率变化率 Change rate of tensile strength and elongation at break after aging
	Mpa ≥	Kgf/cm ²	% ≥		
强撕裂工作条件 (H)	24	240	450	120	-20~+25
强磨损工作条件 (D)	18	180	400	100	-20~+25
一般工作条件 (L)	15	150	350	200	-20~+25

棉布输送带

Cotton conveyor belt

用途 Application >>>

应用于普通煤矿, 水泥厂, 钢铁厂, 冶金业, 建筑业, 港口等。
Used in mine, cement plant, Steel and Iron factory, metallurgy, construction, ports and etc.

特点 Feature >>>

传统型输送带, 用于中短距离输送物料。

Traditional conveyor belts, suitable for medium and short distance transportation of materials.

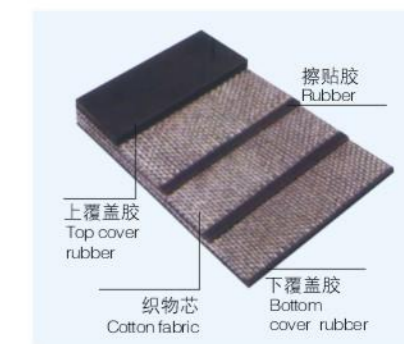

织物芯物理性能 Physical property of fabric >>>

织物类型 Fabric type	织物构造 Fabric structure		织物型号 Fabric Specs	胶布厚度 Ply thickness (mm/p)	强度系列 (N/mm) Strength series					覆盖厚度 (mm) Cover thickness		宽度范围 Width (mm)	
	经 Warp	纬 Weft			2层 2ply	3层 3ply	4层 4ply	5层 5ply	6层 6ply	上覆盖胶 Top cover	下覆盖胶 Bottom cover	切边 Cut edged	包边 Round edged
全棉 Cotton CC	棉 Cotton C	棉 Cotton C	CC-56	1.10	112	168	224	280	336	2-8	0-4.5	400-2200	1.10
涤棉 Polyester cotton TC	涤棉 Polyester cotton TC	棉 Cotton C	TC-70	1.00	140	210	280	350	420	1.5-8	0-4.5	400-2200	1.00

覆盖层物理性能 Physical property of cover rubber >>>

覆盖层类别 Type	拉伸强度 Tensile	扯断伸长率 Elongation		磨损 Abrasion	老化后拉伸强度和扯断伸长率变化率 Change rate of tensile strength and elongation at break after aging
	Mpa ≥	Kgf/cm ²	% ≥		
强撕裂工作条件 (H)	24	240	450	120	-25~+25
强磨损工作条件 (D)	18	180	400	100	-25~+25
一般工作条件 (L)	15	150	350	200	-25~+25

当覆盖厚度为0.8mm-1.6mm时: 拉伸强度和扯断伸长率允许比表中值低15%。
Cover thickness (0.8mm-1.6mm): tensile strength and elongation at break can be 15% below above is allowable.



耐酸碱输送带

Chemical resistant conveyor belt

织物型号Fabric Spec EP-80~EP-400 NN-80~NN-400 CC-56 T.C-75

宽度width(mm) 300~2300

产品特性 >>>

选用棉帆布、尼龙帆布或聚酯帆布作带芯, 带体弹性好, 成槽性能好, 使用伸长率小。选用耐酸碱的材料加工而成覆盖层, 具有良好的抗化学腐蚀性能和良好的物理性能。

Product characteristics >>>

Because the belt core selects cotton-duck, nylon-duck or EP-duck, the belt has good elasticity, excellent troughability, and low elongation. The rubber cover which is made from chemical resistant materials, has fine anti-chemical corrosiveness and good physical properties.

用途 Application >>>

适用于化工厂、化肥厂、造纸厂等厂矿企业输送含有酸性或碱性等腐蚀性的物料。

It could be used to deliver acid or alkaline corrosive materials in chemical plants, fertilizer plants and paper mills.

技术指标 Technical indexes >>>

类别	浸泡溶液	浓度	浸泡条件 温度 X 时间	浸泡前后性能变化率	
				体积膨胀率	强度变化率
A1	盐酸 (HCl)	18%	50°C X 96h	+10%以下	-10%以内
A2	硫酸 (H ₂ SO ₄)	50%	50°C X 96h	+10%以下	-10%以内
A3	氢氧化钠 (NaOH)	48%	50°C X 96h	+10%以下	-10%以内



一般用途织物芯阻燃输送带

Fire resistant conveyor belt

产品特性 Product characteristics >>>

本产品由尼龙帆布、聚酯帆布作芯带, 覆合阻燃复盖胶。经过压延、成型、硫化等工序精制而成。适合于煤矿井上、热电厂等易燃易爆环境下输送非腐蚀性的块状、粒状、粉末状物料, 如煤炭等散料或成件物品。

This product is covered by flame retarding double sizing and its belt core is composed of nylon canvas and polyester cans. It is manufacturing through such processing procedures as rolling, moulding and vulcanization. It could be used to transport non-corrosive block-like, grain-like and powder-like materials in flammable and combustible situations like mines and thermal power plant, such as bulks and products like coals.

覆盖层性能 Cover rubber property >>>

覆盖层性能级别 Type	拉伸强度 Tensile	扯断伸长率 Elongation	磨损 Abrasion
	Mpa≥	%≥	mm ³ ≤
D	18.0	450	200
L	14.0	400	250

当覆盖层厚度为0.8mm~1.6mm时, 试样厚度可以是切出的最大厚度, 此时, 拉伸强度和扯断伸长率允许比表中值低15%以内。
注: D—强磨损工作条件; L—一般工作条件。

安全性能 Safety property >>>

项目	阻燃性能等级	
	K级	K级
火焰持续时间	六个有覆盖层试样的火焰持续时间合计不得大于45s, 任何单个值不得大于15s	三个有覆盖层试样的火焰持续时间的平均值不得大于60s
导静电性能再燃性	不大于3 × 10 ⁶ 任何一个试样上应不重新出现火焰	



耐油输送带

Oil resistant conveyor belt

产品特性及用途 Product characteristics and appication >>>

本产品由全棉帆布、维棉、涤棉、尼龙、聚酯交织浸浆帆布经压延、贴胶、裁断成型、加热硫化等工序精制而成。覆盖胶选用耐油要求不同的特种耐油胶,经过特殊工艺加工覆盖在胶带表面,保护带芯不受侵害。

It uses cotton canvas, nylon canvas and polyester canvas as belt core. Hence, the belt body enjoys good elasticity, excellent grooving forming ability and small tensile rate. The covering layer is processed with acid and alkaline resistance materials. Therefore, it is characterized by excellent chemical corrosion resistance performance and good physical performance.

技术指标 Teshnical indexes >>>

- 1、耐油输送带根据覆盖胶性能分为耐磨损型(D)、一般型(L)二种类。
- 2、耐油性能分为两种级别。

Oil resistance conveyor belts could be classified into wearing resistance type (D) and general type (L) according to performance of the covering sizing.

The oil resistance could be classified into two levels.

类型	拉断强度 Mpa	拉断伸长率 %	磨耗量 mm
LO	≥14.0	≥350	≤200
DO	≥16.0	≥350	≤160

注: LO—一般条件下的耐油输送带; DO—强耐磨损耐油工作条件下的输送带。

用途 USES

该产品适合于输送油性物料及油态工作场合下使用。

This product could be used to deliver oil materials or applied in situations with oil.



耐寒输送带

Cold resistant conveyor belt

织物型号Fabric Spec EP-80~EP-400 CC-56 T.C-56

宽度width (mm) 300~2000

产品特性 >>>

选用棉帆布、尼龙帆布、聚酯帆布作为带芯。覆盖胶采用天然橡胶与顺丁橡胶的并用胶,具有弹性高,耐冲击,耐寒性等特点,能在零下40℃的环境下正常使用。

Product characteristics >>>

We select cotton canvas, nylon canvas and polyester canvas as belt cores. As for covering sizing, we adopt the blend of natural rubber and butadiene rubber, because the blend enjoys high elasticity, impact resistance and cold resistance and could be normally used in the situation with the temperature of below 40℃.

用途 >>>

适用于寒冷地区露天或冷冻仓库等场合输送物料。

Application >>>

It could be used to deliver materials in cold open-air areas or frozen warehouses.

技术指标 >>>

- 1、耐寒输送带根据覆盖胶性能分为:耐划裂型(H)、耐磨损型(D)、一般型(L)三种类型。
- 2、根据耐寒性能分为C1和C2两种级别。C1使用环境温度为-45~+50℃; C2使用环境温度为-60~+50℃。

Technical indexes >>>

Cold resistance conveyor belts could be classified into three types as Laceration resistant type (H), Anti-abrasive type (D) and General type (L) according to performance of the covering sizing. It could be classified into two levels as C1 and C2 according to the cold resistance. The operation temperature for C1 is -45~+50℃ and the operation temperature for C2 is -60~+50℃.

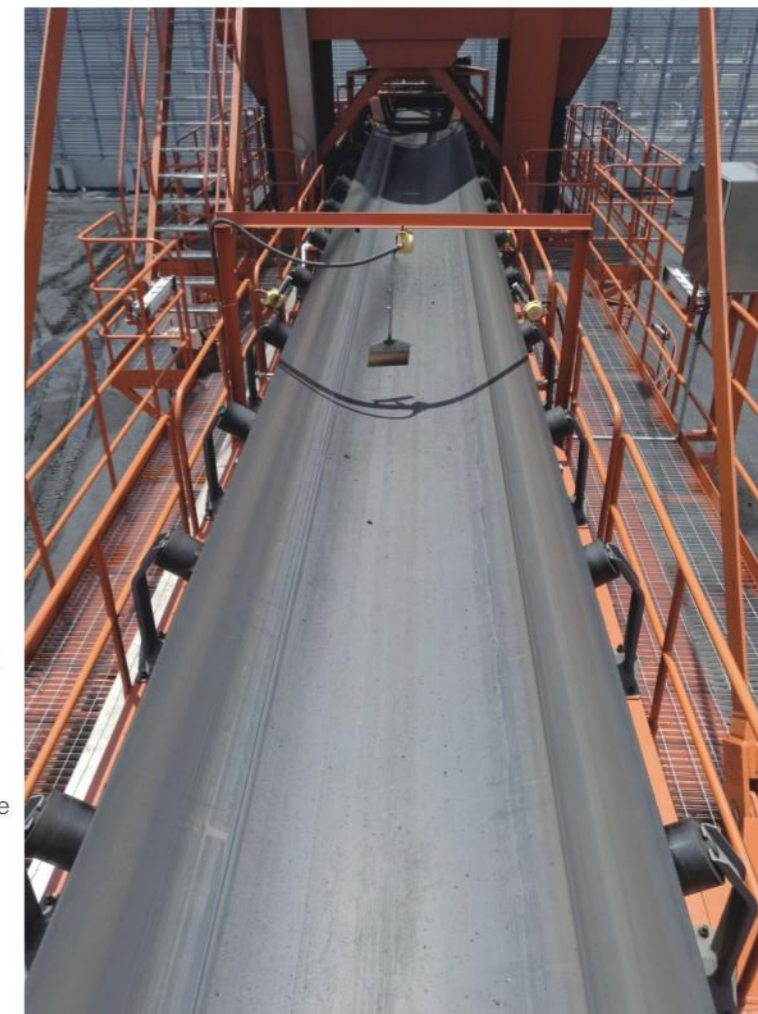

糙面输送带

Rough top conveyor belt

应用领域 >>>

主要应用于轻工、汽配零部件、农业等输送场所。

Application >>>

It mainly applied in such delivery situations as light industry, vehicle parts and agriculture.

产品特点 >>>

- 1、独特表面缓冲效果, 更适宜输送易碎品、易变形产品;
- 2、提升了输送角度20度到30度;

Product characteristics >>>

The unique surface plays a role in buffer. It is applicable to deliver fragile and deformable products.

The delivery angle could be adjusted to 20°C-30°C

技术参数 Technical parameters >>>

- | | |
|-----------------------|--|
| 1、骨架材料: ep、nn; | Frame materials: ep, nn ; |
| 2、强力范围: 100至3150N/mm; | Strong range: 100 to 3150N/ mm ; |
| 3、带宽: 300至2000mm; | Bandwidth: 300 to 2000mm ; |
| 4、覆盖层性能: 耐磨、耐油、阻燃等。 | Overlay performance: abrasion resistance, oil, fire-retardant. |

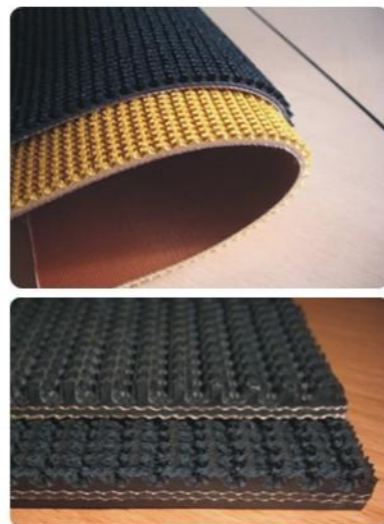

花纹输送带

Chevron conveyor belt

织物型号Fabric Spec EP-80~EP-400 NN-80~NN-400 CC-56 T.C-56

宽度width (mm) 300~2000

形状和特征 shape and character >>>

面上有高于带体的“人”字形花纹, 花纹可是开口的, 也可是封闭的, 每一种花纹又可分为高中低三种。

On the surface of the belt, there is chevron pattern higher than the belt body. The pattern may be either open-end or closed. Each kind of pattern includes three types, high, medium and low.

用途 Usage >>>

适用于≤40度倾角的粉状、颗粒状、小块物料输送, 也可输送包装袋物料。

It can convey powder, granulated and small lump materials at the inclination of no more than 40, it can also convey packaged materials.

Patterned >>>

花纹输送带是由带体和花纹部分组成, 由于运输的物料不同和输送机倾角大小, 要求花纹的形状和高低深浅也不同。

Patterned conveyor belt is composed of belt carcass and pattern. The shape and height(depth) of pattern is subject to the material it convey and the the angle of the machine.



波形挡边输送带

Side wall conveyor belt

产品特点

Product characteris >>>

输送角度0°-90°.占地面积小

Feature: the transmission angle of conveyor is 0-90, small area.



波形挡边种类及示意图 >>>

The type and sketch map of conveyor belt with corrugated flange

S型



W型

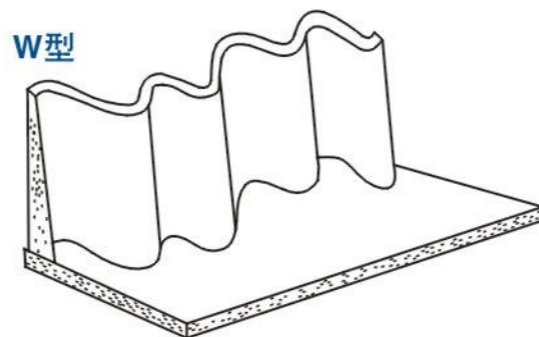

环形输送带 Endless conveyor belt

环形输送带是在生产过程中将输送带制成无接头环形输送带, 其特点是带芯没有接头, 没有因接头处早期损坏带而影响使用寿命, 胶带表面平整、张力均匀。因此胶带运转平稳, 使用伸长率小。

Endless conveyor belt is conveyor belt that has been made into endless without joint in the process of production, its feature is that there is no joint in belt carcass, and the belt shall not be shortened in service life due to early failure in the joints or the belt. The belt is flat in surface and even in tension. Hence, the belts could operation steadily with low tensile rate.

本产品分强力型和普通型二种型号, 选用经过特殊浸渍定型处理, 附着强度大, 高强力的尼龙聚酯或维棉帆布作骨架层, 配制强度高, 弹性大, 耐冲击、耐撕裂、耐磨性能优良的覆盖胶, 制作成环形输送胶带。本产品适用于中小型皮带输送机使用, 胶带不需现场接头, 只需将胶带套入辊筒, 即可运行, 节省时间。

This product could be classified into such two types and strong type and general type. We select nylon polyester or Malvi cotton canvas as framework layer, because they feature high adhesiveness and high strength after being processed through special dipping. After forming the covering size characterized by high strength, good elasticity, impact resistance, tearing resistance and excellent wearing resistance, we could manufacture the endless conveyor belt. This product could be applied in medium and small belt conveyors. The sizing belt needs not to be contacted on site. Operators only need to set the belt into the drum for operation, which could save time

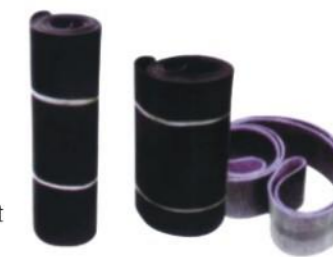

食品输送带 White conveyor belt

用途 Usage >>>

适用于食品工业或粮食部门运输散装、听装、成包成箱的粮食或食品。

Suitable for conveying cereals in bulk or packed in tins, bales of cases in food industry or cereal industry

产品特性 Product characteristics >>>

选用高强度优质全棉、尼龙、聚酯帆布作带芯, 带体弹性好, 不易变形。选用纯天然橡胶和无污染配剂制成白色或浅色, 无污染, 无影响食品卫生异味覆盖层。产品配方设计合理, 符合卫生指标, 色泽适度, 轻巧耐用。

The product selects cotton canvas, nylon canvas or EP canvas as carcass. The belt body has good elasticity and small distortion. Cover rubber of the belt is made of pure natural rubber and non-pollutive additives. The cover rubber is white color, nonpollutive, with no peculiar smell. The compounding formula of the product is reasonable, conforming to all hygienic index. The belt is white color, light and durable.



平胶带

Flat transmission belt

产品特性 Product characteris >>>

普通平带又称为传动带, 一般采用优质全棉帆布作为骨架层, 帆布表面擦、贴适理胶料后, 再由多层胶帆布粘合在一起构成平带, 平带具有强度高、耐老化、屈挠性能好、使用伸长率小等优良性能。主要用于工矿、码头、冶金等部门, 还广泛用于机械传动和大功率光面加工、农机灌溉、木材切割等工农业的动力设备中, 因此在动力设备中发挥着越来越重要的作用。

Common flat rubber belt, also called transmission belt, usually uses high quality cotton canvas as skeleton layers, which surface with rubber. After the surface of the canvas is scrubbed and coated with appropriate rubber, several layers adhere together to form the flat rubber belt. The flat rubber belt has the characteristics of high strength, good flexibility, and small elongation. It is mainly used in factories, mines, docks, metallurgical industry, and also widely used in power machine for transmission, in the processing of grains like rice and wheat, irrigation equipment, wood cutting and others, plays more and more important role in the power transmission equipment.

产品类别 Product classification >>>

切边式: cut edge flat rubber belt

切边式平带和整幅帆布贴合成型, 侧面为切割面形成的平面, 带边平面部位涂胶浆。

Cut edge flat rubber belt is manufactured by adhering several layers of full width canves together, the sides of the belt are formed by cutting, the belt edge surfaces are coated with rubber paste.

包边式: Fold edge flat rubber belt 包边式平带用数层帆布包叠, 侧面为弧形面。

Fold edge flat rubber belt is folded by the outer ply or plies of canvas, and the sides of the belts are round.



普通V带

Classical wrapped v-belt

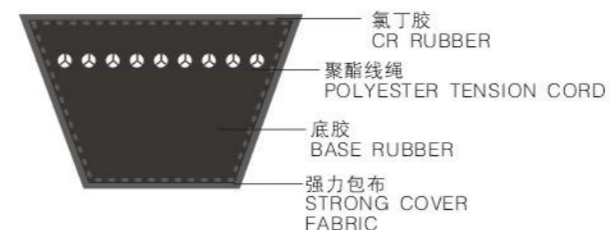

特点 Features >>>

良好的操作安全性能	Excellent operational safety
极高的传动效率	Optimal running characteristics
功率同步传递	Equal power transmission
包布耐磨性极好	Abrasion-resistant cover fabric
普遍使用	Universal usage possibilities

规格型号 Sections	长度范围 (毫米) Length Range(mm)
A/13	2650~8000mm
B/17	2650~14800mm
20	1549~8000mm
C/22	2650~20000mm
25	1549~8000mm
D/32	2750~20000mm
E/38	4500~20000mm

窄V带

Wedge wrapped v-belt

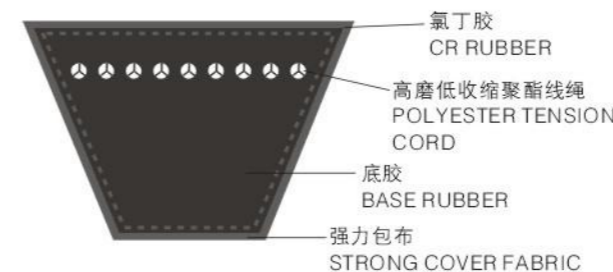

特点 Features >>>

极高的性能
结构紧凑, 节省空间的外形
性价比高
低成本维护
长度误差小, 可配组
散热性好

Extremely high performance
Compact, space-saving shape
Efficient price/performance ratio
Low maintenance costs
Small length error
Good heat dissipation

规格型号 Sections	长度范围 (毫米) Length Range(mm)
3V/9N, SPZ	1549~5334mm
5V/15N	1549~14910mm
8V/25N	3350~14910mm
SPA	1549~8000mm
SPB	1549~14910mm
SPC	1600~20000mm



产品出口整装待发 PRODUCTION PREPARING FOR EXPORT



树富大形象 创富岳品牌